

Heating

Cooling

Fresh Air

Clean Air



Zehnder Comfosystems ComfoAir 200

zehnder



The **Zehnder ComfoAir 200** heat recovery ventilation system is a compact, centralised unit which is highly suited to new build as well as renovation projects. The CA200 works around the clock to extract air from wet rooms (kitchens and bathrooms) and combines maximum comfort with simple operation and high efficiency.

It extracts the heat energy which would otherwise have been lost during the extract process and transfers this to the fresh, filtered supply air drawn in from the outside. This is done using efficient counter-flow heat exchangers which can recover up to 95% of heat that would otherwise have been exhausted into the atmosphere.

Unique benefits - why choose the ComfoAir 200?

- Can be mounted on either walls or ceilings
- The particularly quiet fans can be adjusted in 1% increments for total occupant comfort control
- Integrates simply and flexibly into building services
-  Best Passive House certified performance in the range

Physical specifications

Weight: 30kg
Ducting:
 Internal Ø - 125mm
 Two step external Ø - either 150mm or 160mm
Condensate connection:
 20mm
Materials:
 Internal body - EPP
 Unit housing - Coated Steel
Fans: EC
Filters:
 Standard - G4
 Optional for supply air - F7

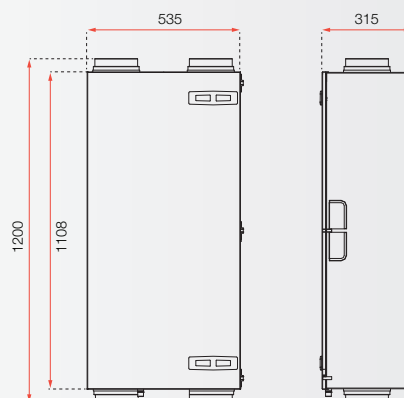

Performance statistics

Model	Energy consumption in Watts				Unit sound level @ 0m in dB(A)			
	Low	Medium	High	Max	Low	Medium	High	Max
CA200	20	46	98	143	29	39	44	48

Low = airflow setting @ 40% motor speed
 Med = airflow setting @ 60% motor speed
 High = airflow setting @ 80% motor speed
 Max = airflow setting @ 100% motor speed

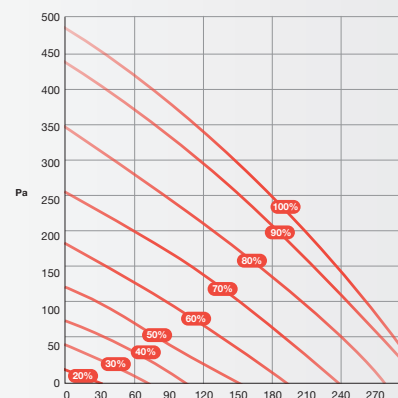

SAP Appendix Q Performance

Exhaust terminal configuration	Specific fan power (W/l/s)	Heat recovery efficiency (%)	Energy Saving Trust best practice
Kitchen + 1 additional wet room	0.91	93	Yes
Kitchen + 2 additional wet rooms	0.90	93	Yes
Kitchen + 3 additional wet rooms	0.93	92	Yes
Kitchen + 4 additional wet rooms	1.05	92	No

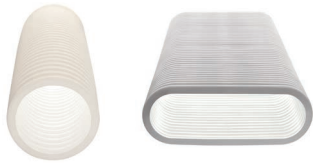

Think system. Think unit. **Think ducting.**

Heat recovery is a system – the unit and the ducting – and it is the combination of these two elements that deliver ventilation into the home.

Ducting is just as important as the unit itself due to its impact on:

- Long term provision of indoor air quality
- Efficiency and airflow performance
- Speed and ease of installation
- Noise transfer around the home
- Occupant comfort and health

ComfoTube and **ComfoTube Flat 51** – our high-performance, semi-rigid air distribution systems – offer a whole host of benefits to developers, installers and homeowners from innovative features including:

- Radial designs giving individual runs to each room
- Flexible design removing the need for bend connection components
- Easy to be maintained and cleaned
- Lightweight and flexible yet still very, very strong - they can withstand the weight of a person without distorting and can even be buried in concrete
- No need for glues or sealants

Key features

- Designed specifically for flats and apartments up to 110m² (2010 Building Regulations)
- Comfort ventilation up to 200m³/h at 200 Pa
- Heat recovery efficiency of up to 95%
- Low energy consumption thanks to EC motors
- Automatic 100% filtered summer bypass

Installation













Wiring:	Must comply with IEE Regulations
Fuse:	3 Amp
Power supply:	230V ~ 50Hz Class II
Power consumption:	Minimum - 9W Maximum - 143W
Orientation:	Wall or ceiling mounting

ComfoAir 200 product codes



ComfoAir 200 Left	CA200L
ComfoAir 200 Luxe Left	CA200LLUXE
ComfoAir 200 Right	CA200R
ComfoAir 200 Luxe Right	CA200RLUXE
ComfoAir 200 Luxe PH Left With pre-heater - a Passive House certified component ^[2]	CA200LLUXEPH
ComfoAir 200 Luxe PH Right With pre-heater - a Passive House certified component ^[2]	CA200RLUXEPH

Control options and ancillaries

	ComfoSense CS67 control unit with mounting box ^[1]	CCS		Filter set - G4	400 100 014
	Wireless control unit	CCRFZ		Filter set - G4/F7	400 100 013
	Three position switch with fault indicator	CCBL		Filter set - F7	400 100 017
	Three position switch	CCB		Enthalpy heat exchanger ^[1]	200 350 615
	0-10v humidity sensor	659 000 330		ComfoPipe 125 ^[1]	Various
	0-10v CO ₂ sensor	659 000 340		ComfoTube Flat 51 ^[1]	Various
				ComfoTube ^[1]	Various

[1] - Detailed literature containing technical data is available on request

[2] - A brochure detailing all of our Passive House components, and the specifically certified data, can be requested or downloaded from our website at www.greenwood.co.uk



Zehnder Comfosystems

Heat recovery ventilation from the experts in energy-efficient, healthy and comfortable indoor climate solutions.

With the continued focus and drive to build highly insulated dwellings, heat recovery ventilation remains the optimal solution for the provision of good indoor air quality throughout the year. Zehnder has more than 40 years' experience in the development and production of ventilation units and this experience forms the basis of well-considered products and systems which have numerous benefits; energy efficiency, comfort, health, ease of use and integration.



Why choose Zehnder Comfosystems?

Zehnder understands the requirements of high performance buildings and offers a full range of solutions to ensure the perfect indoor climate. **Some of the key benefits of choosing Zehnder as your solution partner are:**

- A full range of whole house heat recovery ventilation units
- Products that are independently tested and approved
- A range that covers all property sizes from smart, urban apartments to large, luxury dwellings
- ComfoAir MVHR units that meet stringent Passive House standards
- Year round comfort with true summer bypass as standard
- Outstanding specific fan power (SFP) and heat exchange efficiencies for real rewards in SAP
- A unique range of high performance ducting to complete the system solution
- An exceptional in-house technical team who can assist with all aspects of your project and are experts on all regulations and standards



Zehnder Group UK Ltd
Greenwood House
Brookside Avenue · Rustington
West Sussex · BN16 3LF

T +44 1903 777333
F +44 1903 782398

comfosystems@zehnder.co.uk
www.zehnder.co.uk

Greenwood Airvac
A Division of Zehnder Group UK Ltd
Greenwood House · Brookside Avenue
Rustington · West Sussex · BN16 3LF

T +44 1903 771021
F +44 1903 782398

info@greenwood.co.uk
www.greenwood.co.uk